

INICIO**MASTER**18º Enduro Tribo da Trilha
20 de março de 2016**IMPORTANTE**18ºENDURO CIDADE DE
SÃO LUDGERO-SCDIRETOR DE PROVA:
GENOIR BRUNING

REALIZAÇÃO:
TRIBO DA TRILHA
CONFIRA SUA PLANILHA,
VEJA SE ESTÁ CORRETO
O NUMERO SEQÜENCIAL
DE TULIPAS.
NOS TRECHOS URBANOS
PREVALECEM AS LEIS DO
CÓDIGO NACIONAL DE
TRANSITO. É OBRIGAÇÃO
RESPEITAR AS
PROPRIEDADES ALHEIAS
E OS MORADORES.
A ORGANIZAÇÃO NÃO SE
RESPONSABILIZA POR
PASSAR PROGRAMAÇÃO DE
NAVEGAÇÃO.
NOS LOCAIS DÚVIDOSOS
SERÃO BANDEIRADOS
(BAMPS).

LARGADA:
CTG BEIRA RIO 09h01minDivisão da Etapa
No neutro principal na
COMUNIDADE DA TAIPANeutro
Salão da Comunidade da
Taipa
1º Etapa 58,24 Km
Horario do primeiro piloto
11:17:00CHEGADA
CTG Beira Rio
2º Etapa 55,20 Km
Horário do primeiro piloto
13:44:00
TOTAL PROVA 113,44Km

QUANDO VOCÊ RECEBE OS
TRECHOS ("CHUPETA")
O NAVEGADOR MOSTRA
NA TELA O TEMPO DE
PROVA. COMPARE COM O
TEMPO DE SUA CATEGORIA
DIVULGADA ABAIXO.
ASSIM VOCÊ EVITA
POSSÍVEL ERRO NA
PROGRAMAÇÃO.

☠ CUIDADO

☠☠ ATENÇÃO

☠☠☠ MUITA ATENÇÃO

Tempo de Prova

MASTER 04:42:57

**AFERIÇÃO**POR FAVOR
RESPEITE
OS MORADORES!**AFERIÇÃO**

0.00		1	AFER
0.03		2	AFER
0.06		3	AFER
0.18		4	AFER
0.46		5	AFER
0.73		6	AFER
0.84		7	AFER

CASA ROSA

1.18

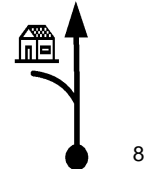
8
 AFER || AFERE | | | |
| NO BAMP | | | |
| 1.352 | | 9 | AFER |
| 0.000 |





INÍCIO DE PROVA
INICIO DE PROVA



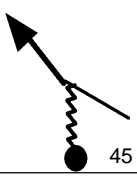

0.00		39	00.00.00
0.03		V	T1
0.06		39	
0.18		V	T1
0.46		39	
0.46		V	T1
SIGA COM CUIDADO			
RESPEITE			
OS			
MORADORES			

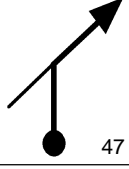
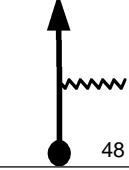
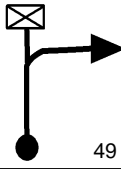
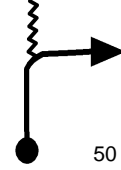
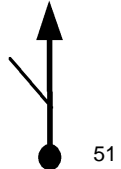
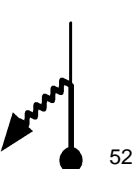
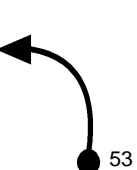
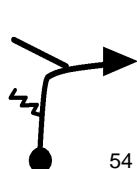
20 de março de 2016		Pág: 004	
0.73		39	
		V	T1
0.83		39	
		V	T1
1.06		39	
		V	T1
1.43		39	
		V	T1
1.55		39	
		V	T1
DESLOCAMENTO			
1.63		4'	00.02.30
		D	T2
CUIDADO			
ATRAVESSE COM ATENÇÃO			
2.24			
		D	T2
FIM			
DESLOCAMENTO			
AFERE			
2.746		42	00.06.30
Afer		V	T3
2.76		42	
		V	T3



20 de março de 2016		Pág: 005	
2.94		42	
		V	T3
3.60		42	
		V	T3
PONTE DO SCHULZ			
4.40		42	
		V	T3
4.61		42	
		V	T3
5.23		42	
		V	T3
6.05		42	
		V	T3
6.17		42	
		V	T3
6.80		42	
		V	T3
7.02		33	00.12.37
0.00		V	T4
0.03		33	
		V	T4

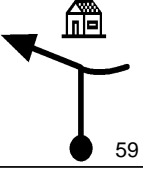

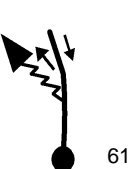
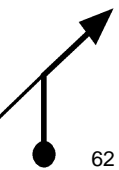
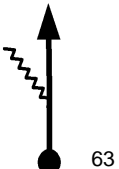
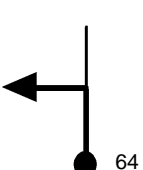

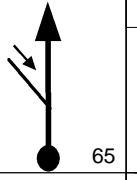
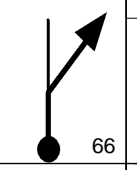
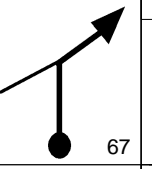
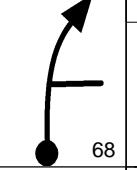
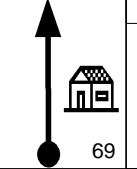
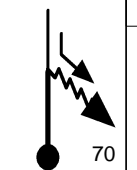
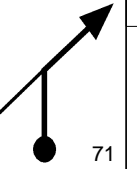
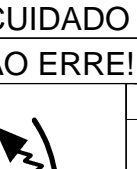
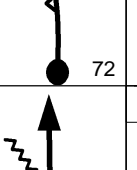
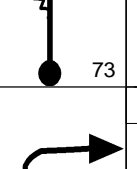
20 de março de 2016		Pág: 006	
0.06		33	
		V	T4
0.12		30	00.12.50
		V	T5
0.29		30	
		V	T5
0.34		38	00.13.16
		V	T6
0.44		38	
		V	T6
0.77		38	
		V	T6
0.86		38	
		V	T6
0.89		38	
		V	T6
0.95		38	
		V	T6
1.04		38	
		V	T6
1.43		38	
		V	T6

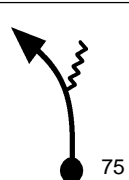
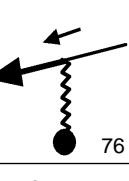

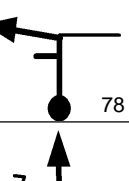
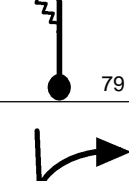
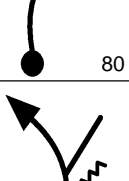
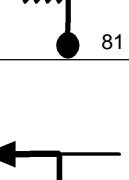
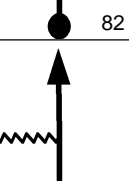
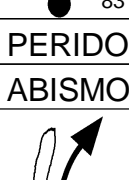
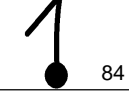

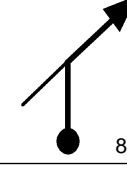
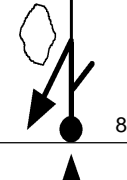
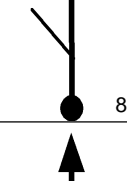
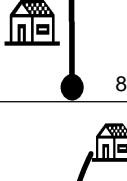
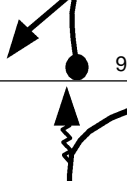
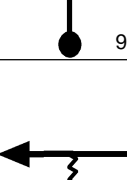
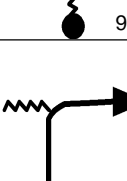
20 de março de 2016		Pág: 007	
1.46		2'	00.15.02
	45	N	T7
1.46		36	00.17.02
	46	V	T8
1.54		36	
	47	V	T8
1.84		36	
	48	V	T8
1.87		36	
	49	V	T8
2.11		36	
	50	V	T8
2.14		36	
	51	V	T8
2.64		33	00.19.00
	52	V	T9
2.96		33	
	53	V	T9
3.22		33	
	54	V	T9
3.38		1'30s	00.20.21
	55	N	T10

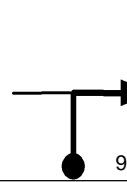



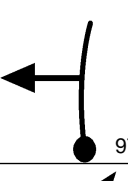
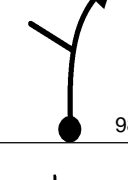
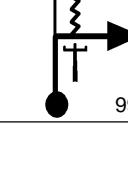
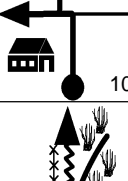

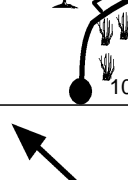
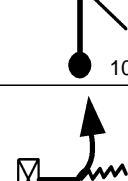
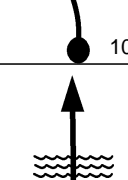



20 de março de 2016		Pág: 008	
3.38		39	00.21.51
	56	V	T11
3.60		39	
	57	V	T11
3.86		39	
	58	V	T11
4.03		39	
	59	V	T11
			
4.16		42	00.23.03
0.00	60	V	T12
0.03		42	
	61	V	T12
0.23		42	
	62	V	T12
0.30		42	
	63	V	T12
0.48		35	00.23.44
	64	V	T13

20 de março de 2016		Pág: 009	
0.70		35	
	65	V	T13
0.75		35	
	66	V	T13
0.90		42	00.24.27
	67	V	T14
1.20		42	
	68	V	T14
1.76		42	
	69	V	T14
1.89		42	
	70	V	T14
2.10		35	00.26.10
	71	V	T15
CUIDADO NAO ERRE!!!			
2.19		35	
	72	V	T15
2.30		35	
	73	V	T15
2.43		35	
	74	V	T15









20 de março de 2016		Pág: 010	
2.47		35	
		V	T15
2.58		35	
		V	T15
2.62		35	
		V	T15
2.78		42	00.27.20
		V	T16
2.83		42	
		V	T16
2.88		42	
		V	T16
2.96		39	00.27.36
		V	T17
3.32		39	
		V	T17
3.47		39	
		V	T17
PERIDO			
ABISMO			
3.51		3'	00.28.26
		N	T18



20 de março de 2016		Pág: 011	
3.51		39	00.31.26
		V	T19
3.71		39	
		V	T19
4.55		39	
		V	T19
4.67		33	00.33.13
		V	T20
4.83		33	
		V	T20
5.12		39	00.34.03
		V	T21
5.20		39	
		V	T21
5.28		39	
		V	T21
5.60		39	
		V	T21
5.74		39	
		V	T21
6.37		2'	00.35.58
0.00		N	T22



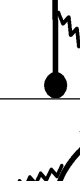

20 de março de 2016		Pág: 012	
0.00		39	00.37.58
		V	T23
0.13		39	
		V	T23
0.25		39	
		V	T23
0.69		39	00.39.02
		V	T24
0.75		39	
		V	T24
0.98		34	00.39.28
		V	T25
ENTRE NO MATO			
1.15		34	
		V	T25
1.28		34	
		V	T25
1.32		42	00.40.04
		V	T26
1.42		42	
		V	T26

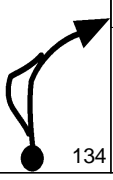
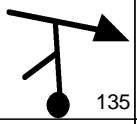

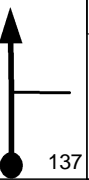
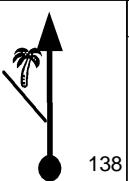
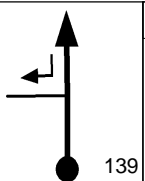
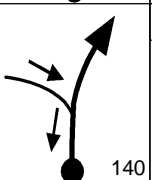
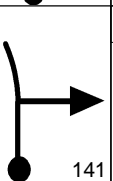
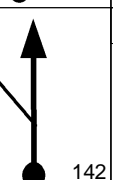
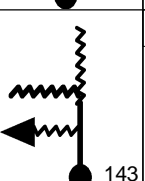

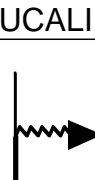
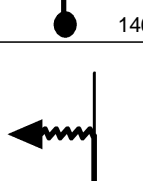
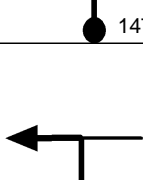
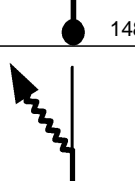
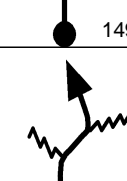
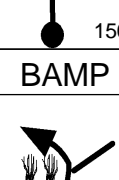

20 de março de 2016		Pág: 013	
1.69		42	V T26
1.76		42	V T26
2.01		42	V T26
CUIDADO ESTRADÃO  CRUZAMENTO			
2.37		2'30s 00.41.34	N T27
2.37		42 00.44.04	V T28
2.69		42	V T28
2.82		45 00.44.43	V T29
ACELERE			
2.87		45	V T29
3.08		45	V T29
3.14		39 00.45.09	V T30



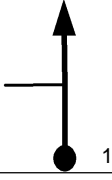





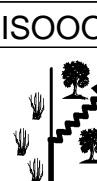
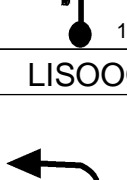
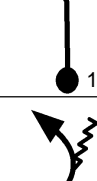
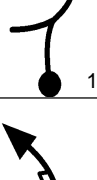

20 de março de 2016		Pág: 014	
3.30		39	V T30
3.45		39	V T30
3.51		39	V T30
3.63		30 00.45.54	V T31
			
RAIZEIRO LISOOOOO			
3.66		30	V T31
PELA ESQUERDA BANHADO			
3.96		30	V T31
4.13		30	V T31
4.89		30	V T31

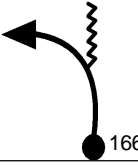





20 de março de 2016		Pág: 015	
4.98		33 00.48.36	V T32
5.15		33	V T32
5.19		33	V T32
5.25		33	V T32
5.33		33	V T32
5.47		33	V T32
5.51		33	V T32
SIGA OS BAMPs			
5.58		36 00.49.41	V T33
INICIO DESLOCAMENTO			
BAMPs			
5.69		5' 00.49.52	D T34
5.78			D T34



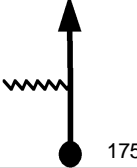

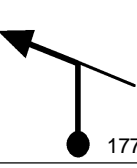
20 de março de 2016		Pág: 016	
5.89		134	D T34
NA PRINCIPAL			
FIM			
DESLOCAMENTO			
		42	00.54.52
6.01		135	V T35
0.00		42	
0.67		136	V T35
0.92		137	V T35
1.10		138	V T35
☠☠☠ MOTO CONTRA			
1.31		139	V T35
1.50		140	V T35
1.88		141	V T36
2.54		142	V T36
3.02		143	V T37

20 de março de 2016		Pág: 017	
3.13		144	V T37
3.17		145	V T37
NO EUCALIPTO			
3.24		146	V T37
3.30		147	V T37
3.45		148	V T37
3.49		149	V T37
3.86		150	V T37
BAMP			
3.90		151	V T37
ENTRE			
NO MATO			
4.04		152	V T38
4.38		153	V T39

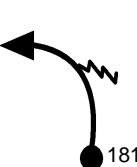
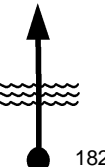

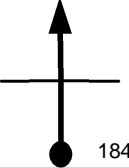
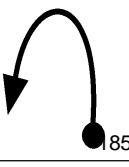
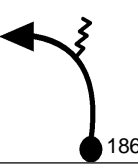
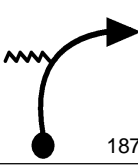
20 de março de 2016		Pág: 018	
4.40		154	V T39
4.52		155	V T39
4.54		156	V T39
4.65		157	V T39
5.03		158	V T39
5.05		159	V T39
LISOOOO			
5.11		160	V T40
LISOOO			
5.16		161	V T40
5.32		162	V T41
6.10		163	V T41

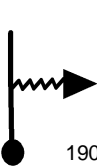

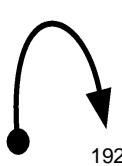
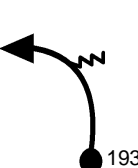

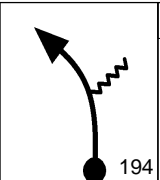
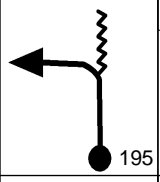
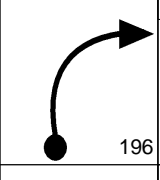
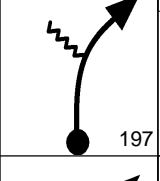
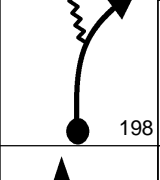
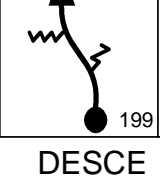
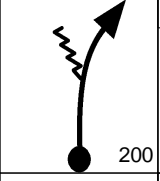
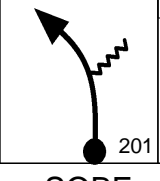
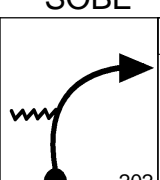
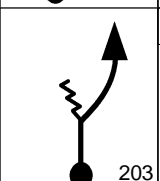
20 de março de 2016		Pág: 019	
6.28		38	
	164 V T41		
6.33		38	
	165 V T41		
6.42		38	
	166 V T41		
6.51		38	
	167 V T41		
6.61		38	
	168 V T41		
FURNINHAS			
6.89		5'	01.05.53
0.00		N	T42
	169	36	01.10.53
0.00		V	T43
	170	36	
0.04		V	T43
	171	36	
0.24		V	T43
	172		
VAMOS COMEÇAR A BRINCADEIRA!			
"BEM VINDOS"			
0.69		40	01.12.02
	173	V	T44

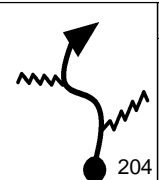
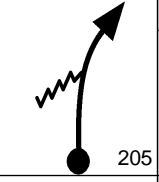
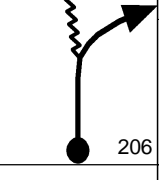
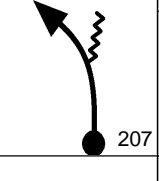
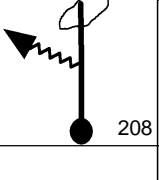
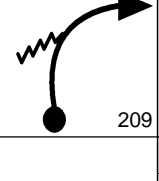
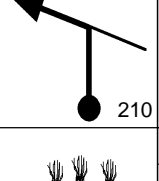

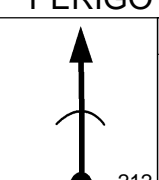
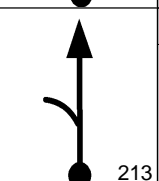

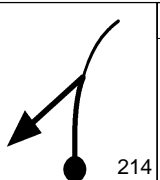
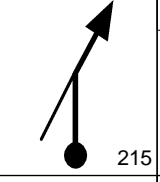
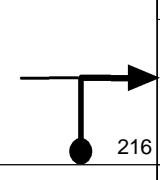

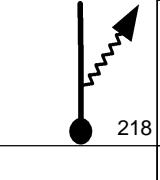
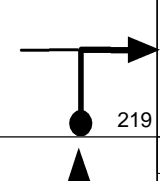
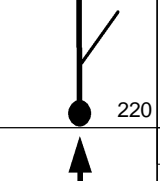

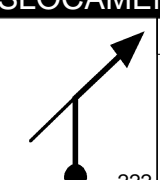
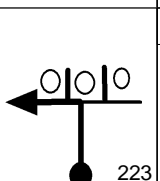
20 de março de 2016		Pág: 020	
1.03		40	
	174 V T44		
1.09		40	
	175 V T44		
1.37		40	
	176 V T44		
1.51		40	
	177 V T44		
1.57		40	
	178 V T44		
1.91		40	
	179 V T44		
			
2.20		36	01.14.18
	180	V	T45
2.50		36	
	181	V	T45
2.97		36	
	182	V	T45





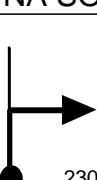
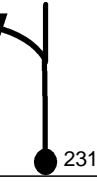

20 de março de 2016		Pág: 021	
3.73		36	
	183 V T45		
3.88		36	
	184 V T45		
4.35		36	
	185 V T45		
4.63		33	01.18.21
	186 V T46		
4.82		33	
	187 V T46		
4.84		33	
	188 V T46		
5.06		33	
	189 V T46		
5.13		33	
	190 V T46		
5.26		33	
	191 V T46		
5.45		33	
	192 V T46		
5.61		39	01.20.08
	193 V T47		



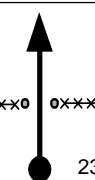
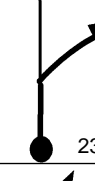

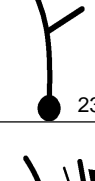
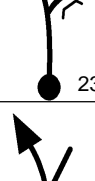
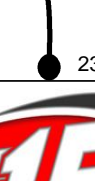

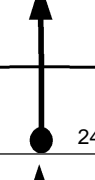
20 de março de 2016		Pág: 022	
5.73		39	V T47
6.08		35 01.20.52	V T48
6.18		35	V T48
6.33		35	V T48
6.41		35	V T48
6.43		35	V T48
DESCE			
6.75		35	V T48
7.21		35	V T48
SOBE			
7.43		35	V T48
7.48		35	V T48

20 de março de 2016		Pág: 023	
7.54		35	V T48
7.85		35	V T48
7.94		35	V T48
8.08		39 01.24.17	V T49
8.32		39	V T49
8.36		39	V T49
8.37		39	V T49
8.41		39	V T49
NAO SALTE			
☠☠☠ PERIGO			
8.74		39	V T49
8.77		39	V T49

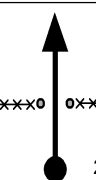
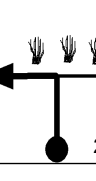
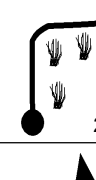
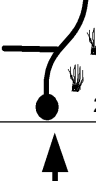
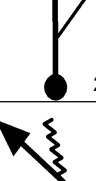
20 de março de 2016		Pág: 024	
8.88		39	V T49
8.94		39	V T49
9.08		6' 01.25.50	N T50
0.00		35 01.31.50	V T51
0.05		35	V T51
0.27		35	V T51
0.31		35	V T51
0.41		35	V T51
INICIO			
DESLOCAMENTO			
0.55		4' 01.32.46	D T52
0.65			D T52

20 de março de 2016		Pág: 025	
0.73		D	T52
0.82		D	T52
FIM DESLOCAMENTO			
0.87		V	T53
1.18		V	T53
1.38		V	T53
1.98		V	T53
MAO NA SOCA			
2.15		V	T54
2.45		V	T54
2.61		V	T54
2.89		V	T54





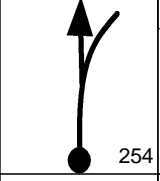
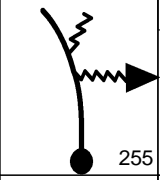
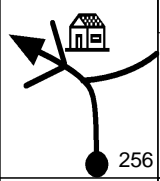
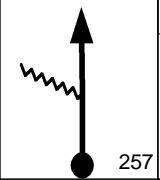
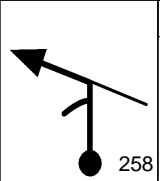
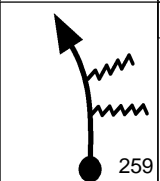
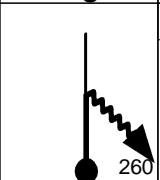
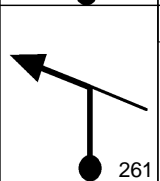
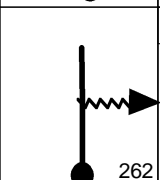
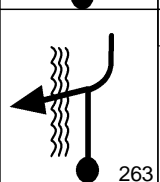

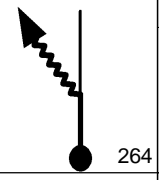
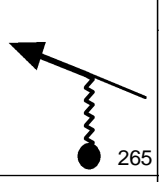
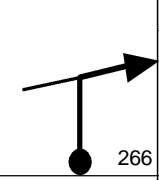
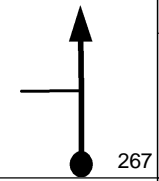
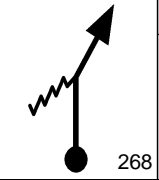
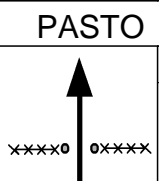
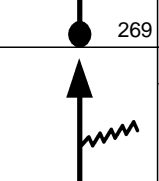
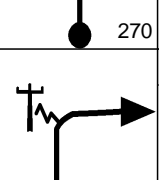
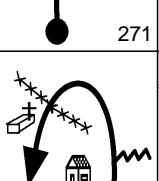
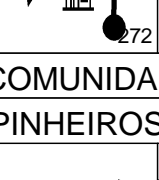
20 de março de 2016		Pág: 026	
2.91		V	T54
3.30		V	T54
3.48		V	T54
3.52		V	T54
3.85		V	T54
3.91		V	T54
			
4.24		V	T54
4.44		V	T54
4.56		V	T55

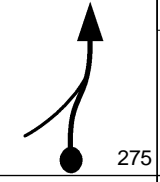
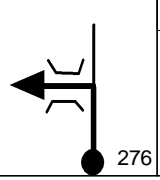
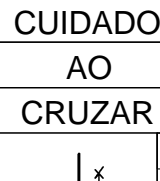
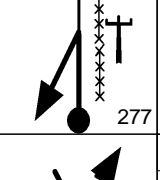
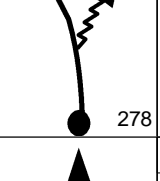
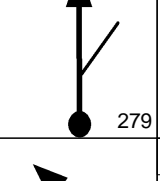
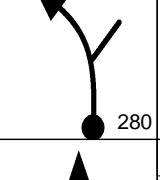
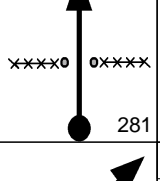
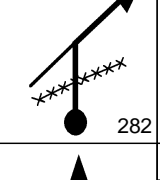

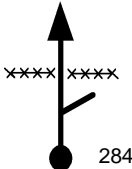

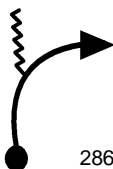
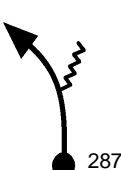
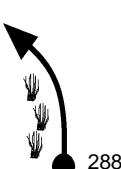
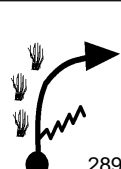

20 de março de 2016		Pág: 027	
4.61		V	T55
4.85		V	T55
5.05		V	T55
5.09		V	T56
5.34		V	T56
5.94		V	T56
6.01		N	T57
6.01		V	T58
6.13		V	T58
6.29		V	T59
0.86		V	T59

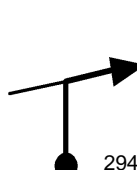

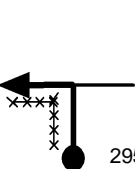
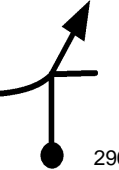

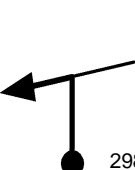
20 de março de 2016		Pág: 028	
SAIA			
DA			
PRINCIPAL			
1.00		30	01.49.39
		V	T60
1.15		30	
		V	T60
1.29		30	
		V	T60
1.31		30	
		V	T60
1.48		30	
		V	T60
1.51		30	
		V	T60
1.56		30	
		V	T60
1.74		30	
		V	T60
1.92		25	01.51.29
		V	T61
2.01		25	
		V	T61



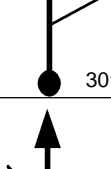

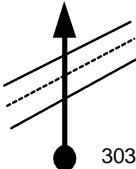
20 de março de 2016		Pág: 029	
2.03		25	
		V	T61
2.06		25	
		V	T61
2.20		25	
		V	T61
2.25		25	
		V	T61
2.53		33	01.52.57
		V	T62
PASTO			
2.97		33	
		V	T62
3.03		33	
		V	T62
3.10		33	
		V	T62
3.20		33	
		V	T62
COMUNIDADE			
RIO PINHEIROS ALTO			
3.30		3'	01.54.21
		N	T63

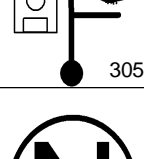

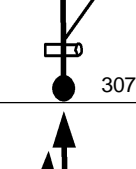
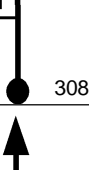
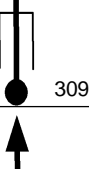
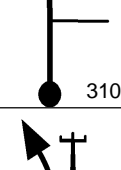
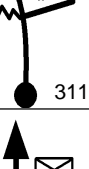

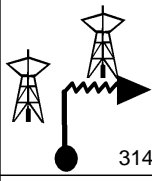
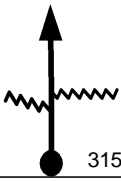

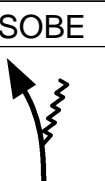
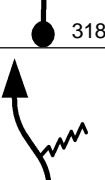
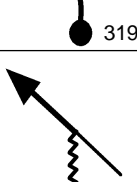

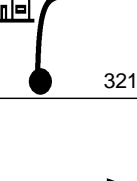
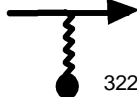
20 de março de 2016		Pág: 030	
3.30		39	01.57.21
		V	T64
3.35		39	
		V	T64
3.75		39	
		V	T64
CUIDADO			
AO			
CRUZAR			
4.68		39	
		V	T64
4.81		39	01.59.41
		V	T65
4.91		39	
		V	T65
5.02		39	
		V	T65
5.15		39	
		V	T65
5.26		39	
		V	T65
5.33		39	
		V	T65



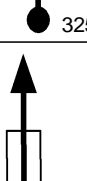



20 de março de 2016		Pág: 031	
5.44		39	
	284	V	T65
5.52		39	
	285	V	T65
5.63		36	02.00.56
	286	V	T66
5.80		36	
	287	V	T66
6.26		36	
	288	V	T66
6.32		36	
	289	V	T66
6.54		36	
	290	V	T66
6.57		2'30s	02.02.30
0.00		N	T67
0.00		42	02.05.00
	292	V	T68
0.39		42	
	293	V	T68
0.69		42	
	294	V	T68

20 de março de 2016		Pág: 032	
0.82		42	
	295	V	T68
1.02		42	
	296	V	T68
1.50		42	
	297	V	T68
2.31		42	
	298	V	T68
3.80		42	
	299	V	T68
			
4.78		42	
	300	V	T68
INICIO DESLOCAMENTO			
4.84		5'	02.11.55
	301	D	T69
5.55			
	302	D	T69
CUIDADO RODOVIA ESTADUAL			

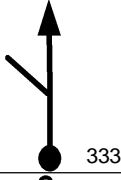

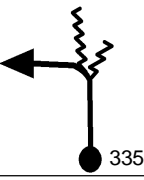
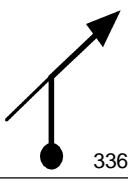

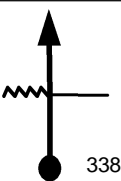
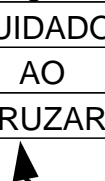
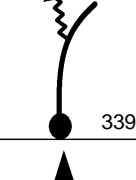
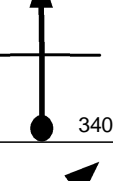



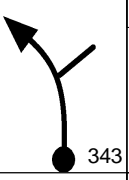
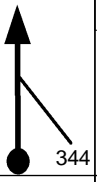
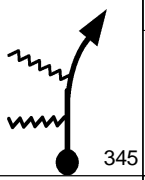
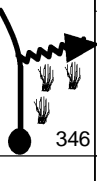
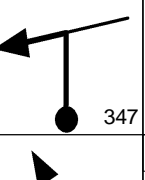
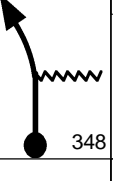
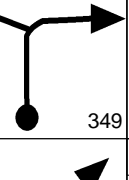
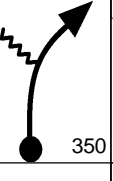
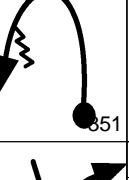
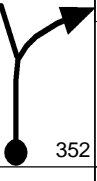
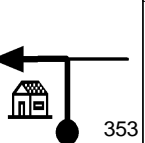

20 de março de 2016		Pág: 033	
5.58			
	303	D	T69
5.77			
	304	D	T69
APOIO COMUNIDADE TAIPA			
5.85		20'	02.16.55
0.00		N	T70
0.00		42	02.36.55
	306	V	T71
0.10		42	
	307	V	T71
0.21		42	
	308	V	T71
0.70		42	
	309	V	T71
1.03		38	02.38.23
	310	V	T72
1.85		38	
	311	V	T72
2.16		38	
	312	V	T72

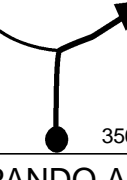

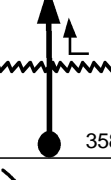
20 de março de 2016		Pág: 034	
2.49		38	
DESCIDA DA TORRE			
2.75		36	02.41.06
4.06		36	
4.15		36	
4.61		32	02.44.12
SOBE			
4.66		32	
4.77		32	
4.84		32	
NO EUCALIPTO			
4.86		32	
4.93		3'	02.44.48
0.00		N	T75





20 de março de 2016		Pág: 035	
0.00		33	02.47.48
0.08		33	
ASFALTO			
0.21		42	02.48.11
0.70		42	
1.04		42	
1.21		42	
1.97		42	
2.28		45	02.51.21
2.42		45	
2.72		45	

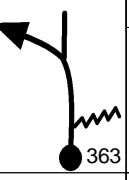

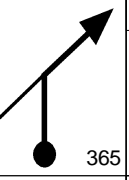
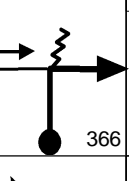
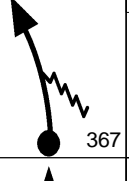
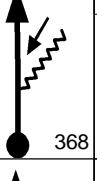
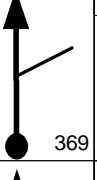
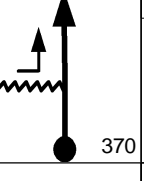
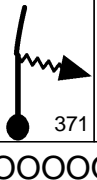
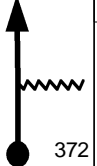

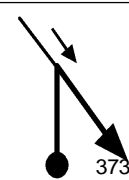
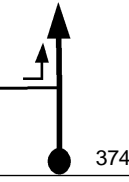
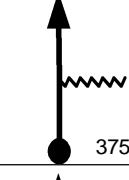
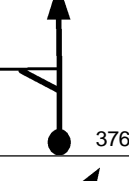
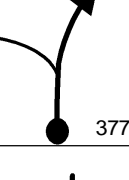
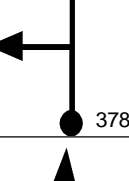
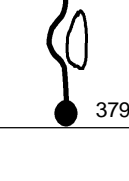

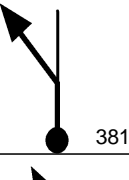
20 de março de 2016		Pág: 036	
2.79		45	
3.56		40	02.52.52
4.02		40	
4.17		3'	02.53.47
4.17		39	02.56.47
4.40		39	
CUIDADO			
AO			
☠☠☠ CRUZAR!			
4.54		42	02.57.21
4.66		42	
4.92		42	
4.95		42	

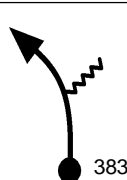
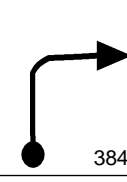
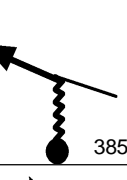

20 de março de 2016		Pág: 037	
5.01		42	
	V	T82	
5.12		42	
	V	T82	
5.16		42	
	V	T82	
5.30		33	02.58.26
	V	T83	
5.50		33	
	V	T83	
5.63		33	
	V	T83	
5.81		36	02.59.22
	V	T84	
5.83		36	
	V	T84	
5.87		36	
	V	T84	
6.04		36	
	V	T84	
6.33		3'	03.00.14
0.00	N	T85	

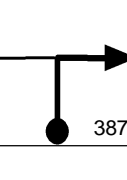
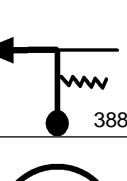

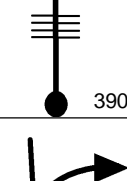
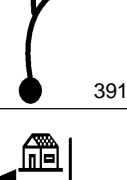
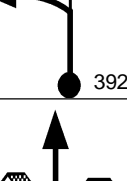
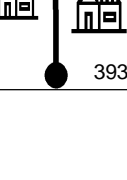



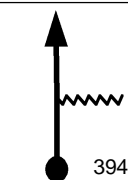
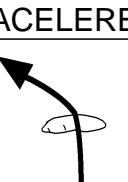
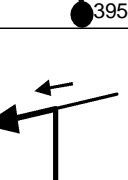
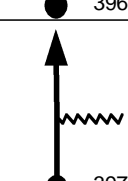
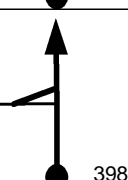
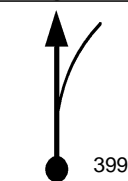
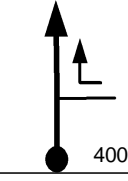
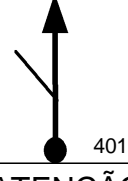
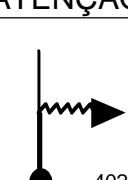

20 de março de 2016		Pág: 038	
0.00		36	03.03.14
	V	T86	
0.06		36	
	V	T86	
0.30		42	03.03.44
	V	T87	
LIMPANDO A VELA			
1.21		54	03.05.02
	V	T88	
1.63		54	
	V	T88	
2.22		24	03.06.09
	V	T89	
			
BAMP'S			
2.40		24	
	V	T89	
2.62		35	03.07.09
	V	T90	
2.72		35	
	V	T90	





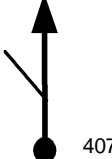
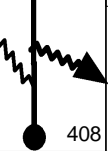
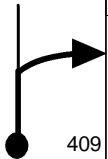
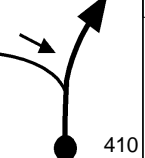

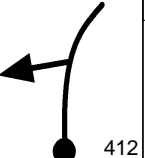

20 de março de 2016		Pág: 039	
2.88		35	
	V	T90	
2.98		35	
	V	T90	
3.07		35	
	V	T90	
3.16		51	03.08.04
	V	T91	
3.75		51	
	V	T91	
3.80		51	
	V	T91	
4.09		51	
	V	T91	
4.13		51	
	V	T91	
4.26		36	03.09.22
	V	T92	
LISOOOOO			
4.44		36	
	V	T92	

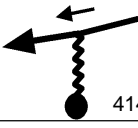

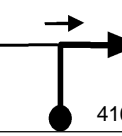

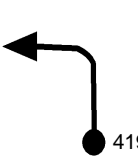
20 de março de 2016		Pág: 040	
4.84		44	03.10.20
	V	T93	
5.17		44	
	V	T93	
5.31		44	
	V	T93	
5.37		44	
	V	T93	
5.75		44	
	V	T93	
5.96		33	03.11.52
	V	T94	
6.01		33	
	V	T94	
6.28		36	03.12.27
	V	T95	
ACELERE			
6.50		33	03.12.49
	V	T96	
6.65		33	
	V	T96	





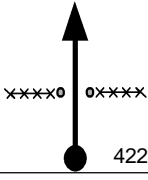
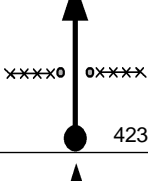

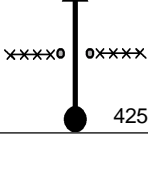
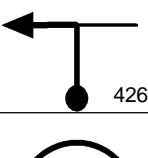

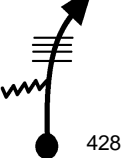
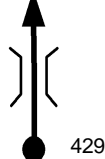
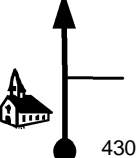
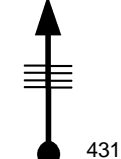
20 de março de 2016		Pág: 041	
6.69		33	
	V	T96	
6.82		33	
	V	T96	
6.87		33	
	V	T96	
6.93		33	
	V	T96	
6.97		33	
	V	T96	
7.00		5'	03.13.43
0.00		N	T97
		36	03.18.43
0.00		36	
	V	T98	
0.22		36	
	V	T98	
0.34		36	
	V	T98	
0.44		36	03.19.27
	V	T99	
0.48		36	
	V	T99	







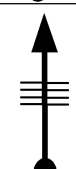



20 de março de 2016		Pág: 042	
0.58		36	
	V	T99	
ACELERE			
0.80		36	
	V	T99	
0.97		40	03.20.20
	V	T100	
1.11		40	
	V	T100	
1.18		40	
	V	T100	
1.56		36	03.21.13
	V	T101	
1.80		36	
	V	T101	
2.02		36	
	V	T101	
ATENÇÃO			
2.56		36	
	V	T101	
2.80		36	
	V	T101	







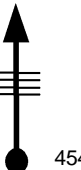
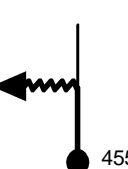

20 de março de 2016		Pág: 043	
 ABISMO			
3.06		36	
		V	T101
3.37		3'	03.24.14
		N	T102
3.37		36	03.27.14
		V	T103
3.52		36	
		V	T103
FAÇA NA CAVEIRA			
3.88		35	03.28.05
		V	T104
4.09		35	
		V	T104
4.25		35	
		V	T104
4.28		35	
		V	T104
4.62		33	03.29.21
		V	T105
4.85		33	
		V	T105

20 de março de 2016		Pág: 044	
5.04		33	
		V	T105
5.06		33	
		V	T105
5.13		33	
		V	T105
5.46		33	
		V	T105
5.53		33	
		V	T105
5.77		38	03.31.27
		V	T106
			
6.10		38	
		V	T106
EROSÕES			
7.00		35	03.33.23
		V	T107
CUIDADO			
EROSÕES			



20 de março de 2016		Pág: 045	
7.17		35	
		V	T107
7.39		35	
		V	T107
7.42		35	
		V	T107
7.49		35	
		V	T107
7.55		5'	03.34.20
0.00		N	T108
0.00		37	03.39.20
		V	T109
0.61		37	
		V	T109
0.66		37	
		V	T109
RIO CORAL			
0.88		37	
		V	T109
0.94		37	
		V	T109

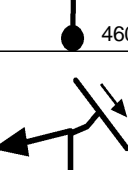

20 de março de 2016		Pág: 046	
1.00		37	V T109
1.89		37	V T109
2.09		37	V T109
2.21		37	V T109
2.85		37	V T109
2.91		37	V T109
3.00		37	V T109
3.15		37	V T109
3.22		40 03.44.33	V T110
EROSÕES			
3.29		40	V T110

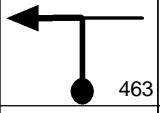
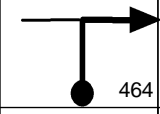
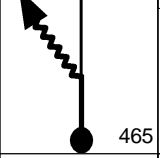
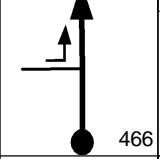
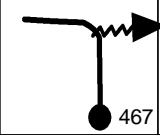
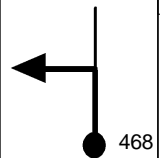
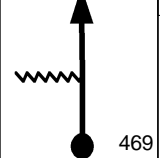
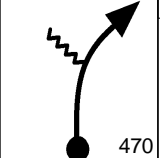
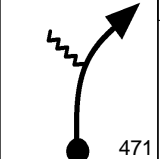
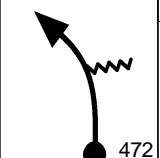
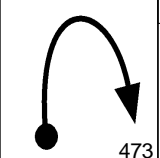
20 de março de 2016		Pág: 047	
3.53		40	V T110
3.82		39 03.45.27	V T111
3.98		39	V T111
4.20		39	V T111
4.49		39	V T111
5.03		39	V T111
5.05		39	V T111
5.16		2' 03.47.31	N T112
0.00		36 03.49.31	V T113
0.31		36	V T113
0.95		36	V T113

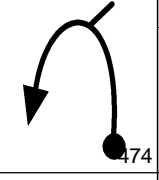
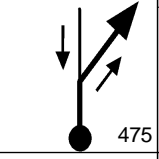
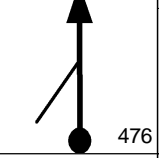
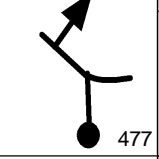
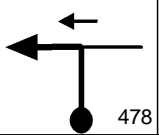
20 de março de 2016		Pág: 048	
1.10		36	V T113
1.26		36	V T113
1.33		37 03.51.44	V T114
EROSÃO			
1.40		37	V T114
1.65		38 03.52.15	V T115
1.94		38	V T115
2.09		38	V T115
2.27		38	V T115
2.57		37 03.53.52	V T115
2.67		37	V T116

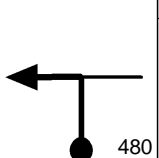
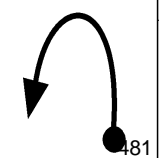
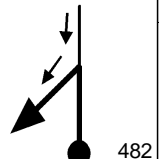

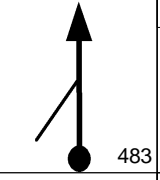
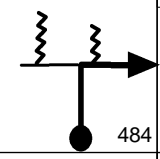
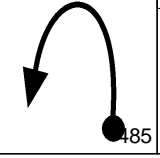

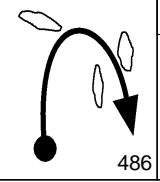
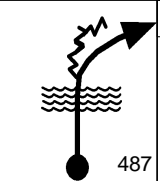
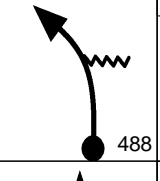
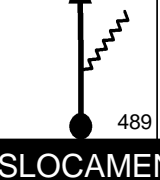
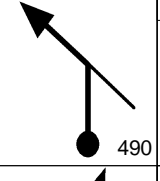
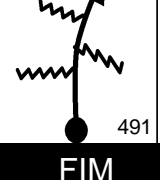
20 de março de 2016		Pág: 049	
3.15		37	V T116
3.34		37	V T116
3.47		37	V T116
3.80		37	V T116
3.93		37	V T116
4.01		37	V T116
4.04		39 03.56.05	V T117
4.16		39	V T117
4.19		39	V T117
4.32		33 03.56.31	V T118
4.56		33	V T118

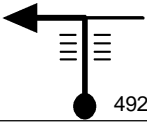
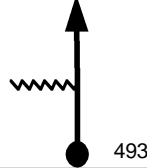
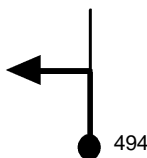
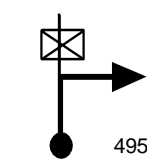
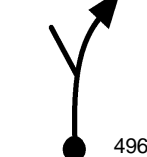
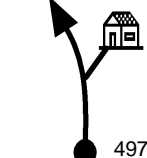
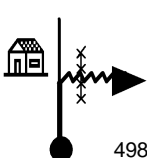
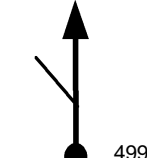
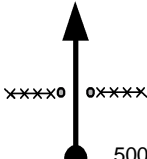
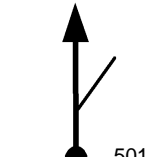
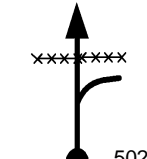
20 de março de 2016		Pág: 050	
5.33		33	V T118
5.57		39 03.58.47	V T119
5.74		39	V T119
5.98		36 03.59.25	V T120
6.74		4' 04.00.41	N T121
0.00		39 04.04.41	V T122
			
0.13		39	V T122
0.50		39	V T122
0.75		39	V T122

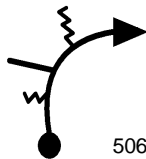
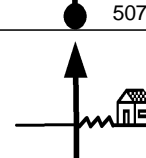
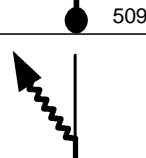
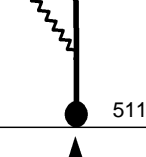
20 de março de 2016		Pág: 051	
0.91		39	V T122
1.15		39	V T122
1.46		33 04.06.56	V T123
EROSÕES			
 DESCIDA			
1.53		33	V T123
PELA DIREITA			
1.65		33	V T123
1.90		33	V T123
2.15		33	V T123
DESLOCAMENTO			
2.20		4' 04.08.17	D T124
2.54		33	D T124
FIM DESLOCAMENTO			

20 de março de 2016		Pág: 052	
2.63		40	04.12.17
		V	T125
3.55		40	
		V	T125
3.57		40	
		V	T125
3.91		40	
		V	T125
4.25		40	
		V	T125
4.52		40	
		V	T125
4.63		43	04.15.17
		V	T126
4.66		43	
		V	T126
4.69		43	
		V	T126
4.76		43	
		V	T126
4.95		43	
		V	T126

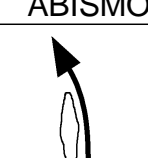
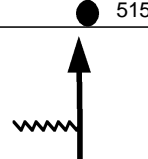
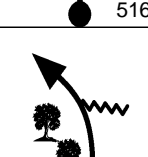
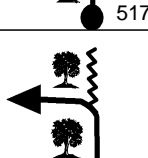
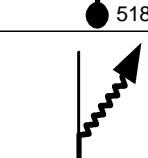
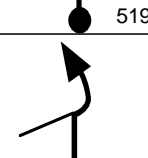
20 de março de 2016		Pág: 053	
5.05		43	
		V	T126
5.44		43	
		V	T126
5.49		43	
		V	T126
5.80		43	
		V	T126
DESLOCAMENTO			
6.14		5'30s	04.17.23
		D	T127
6.35		43	
		D	T127
6.81		43	
		D	T127
6.84		43	
		D	T127
FIM			
DESLOCAMNETO			
6.86		39	04.22.53
		V	T128
6.96		39	
		V	T128

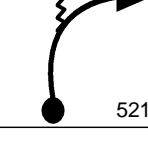
20 de março de 2016		Pág: 054	
7.06		39	
		V	T128
7.12		39	
		V	T128
ABISMO			
7.22		39	
		V	T128
7.43		39	
		V	T128
7.48		39	
		V	T128
7.52		40	04.23.54
		V	T129
7.82		40	
		V	T129
8.03		40	
		V	T129
EROSÕES			
PERIGO			
8.12		40	
		V	T129
8.41		40	
		V	T129

20 de março de 2016		Pág: 055	
PARE			
PERIGO			
8.67		2'	04.25.37
0.00		N	T130
0.00		42	04.27.37
0.11		V	T131
0.47		V	T131
0.54		V	T131
1.03		V	T131
1.18		V	T131
1.74		V	T132
CUIDADO AO CRUZAR			
1.86		V	T132
2.31		V	T132

20 de março de 2016		Pág: 056	
2.67		38	04.31.35
2.80		V	T133
3.45		V	T133
3.50		V	T133
4.08		N	T134
4.08		42	04.35.48
5.97		V	T135
RESPEITE OS MORADORES			
7.30		V	T136

20 de março de 2016		Pág: 057	
7.36		V	T136
PARE			
ASFALTO			
7.44		V	T136
7.51		V	T136
7.60		V	T136
7.68		V	T136
7.75		V	T136
7.82		V	T136
7.91		V	T137
8.05		V	T137
8.32		V	T137

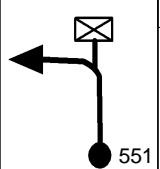
8.61		38	
		V	T137

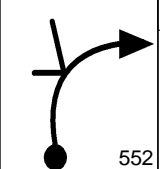
8.76		38	
		V	T137

FIM DE PROVA

PARABENS!!

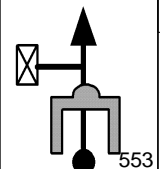
8.82		38	04.42.57
		V	T137

FIM DE PROVA !!



www.t15.com.br

Tempo de Prova

MASTER 04:42:57

FIM