

INICIO**OVER45 - DUPLA - ESTRE**

18º Enduro Tribo da Trilha
20 de março de 2016

IMPORTANTE

18ºENDURO CIDADE DE
SÃO LUDGERO-SC

DIRETOR DE PROVA:
GENOIR BRUNING

REALIZAÇÃO:
TRIBO DA TRILHA
CONFIRA SUA PLANILHA,
VEJA SE ESTÁ CORRETO
O NUMERO SEQÜENCIAL
DE TULIPAS.
NOS TRECHOS URBANOS
PREVALECEM AS LEIS DO
CÓDIGO NACIONAL DE
TRANSITO. É OBRIGAÇÃO
RESPEITAR AS
PROPRIEDADES ALHEIAS
E OS MORADORES.
A ORGANIZAÇÃO NÃO SE
RESPONSABILIZA POR
PASSAR PROGRAMAÇÃO DE
NAVEGAÇÃO.
NOS LOCAIS DUVIDOSOS
SERÃO BANDEIRADOS
(BAMPS).

LARGADA:
CTG BEIRA RIO 09h01min

Divisão da Etapa
No neutro principal na
COMUNIDADE DA TAIPA

Neutro
Salão da Comunidade da
Taipa
1º Etapa 58,24 Km
Horario do primeiro piloto
11:17:00

CHEGADA
CTG Beira Rio
2º Etapa 55,20 Km
Horário do primeiro piloto
13:44:00
TOTAL PROVA 113,44Km

QUANDO VOCÊ RECEBE OS
TRECHOS ("CHUPETA")
O NAVEGADOR MOSTRA
NA TELA O TEMPO DE
PROVA. COMPARE COM O
TEMPO DE SUA CATEGORIA
DIVULGADA ABAIXO.
ASSIM VOCÊ EVITA
POSSÍVEL ERRO NA
PROGRAMAÇÃO.

 CUIDADO

  ATENÇÃO

   MUITA ATENÇÃO



Tempo de Prova

OVER45 - DUPLA - ESTRE 04:46:22

**AFERIÇÃO**

POR FAVOR
RESPEITE
OS MORADORES!

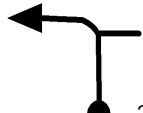
AFERIÇÃO

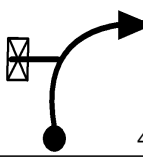
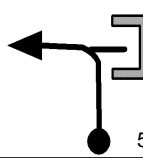
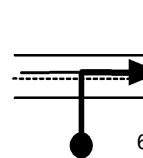
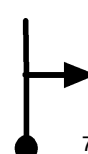
0.00		1	AFER
0.03		2	
0.06		3	
0.18		4	
0.46		5	
0.73		6	
0.84		7	

CASA ROSA

1.18



8

AFERE

NO BAMP

1.352

0.000



9

**INÍCIO DE PROVA**
INICIO DE PROVA

0.00

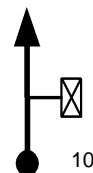

10

39 00.00.00
V T1

0.03

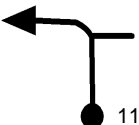

11

0.06

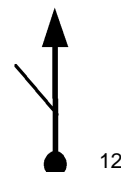

12

0.18

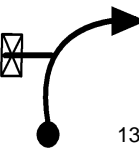

13

0.46

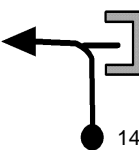

14

SIGA COM CUIDADO

RESPEITE









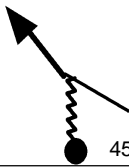

OS

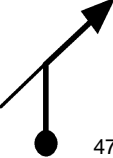

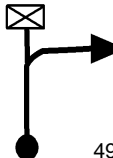
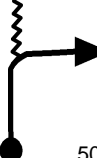

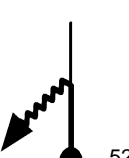

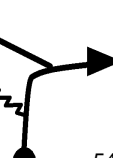
MORADORES





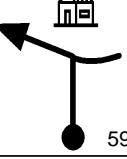

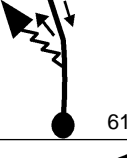

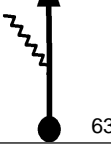
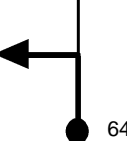
20 de março de 2016		Pág: 004	
0.73		15	
0.83		16	
1.06		17	
1.43		18	
1.55		19	
DESLOCAMENTO			
1.63		20	4' 00.02.30 D T2
CUIDADO			
ATRAVESSE COM ATENÇÃO			
2.24		21	
FIM			
DESLOCAMENTO			
AFERE			
2.746		22	42 00.06.30 V T3
Afer			
2.76		23	

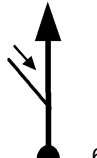

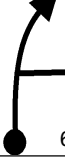

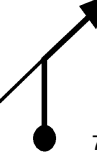
20 de março de 2016		Pág: 005	
2.94		24	
3.60		25	
PONTE DO SCHULZ			
4.40		26	
4.61		27	
5.23		28	
6.05		29	
6.17		30	
6.80		31	
7.02		32	33 00.12.37 V T4
0.00			
0.03		33	

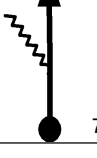



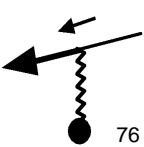
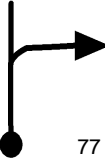
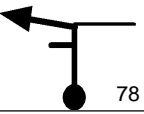
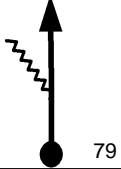

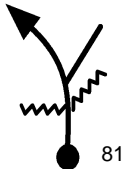
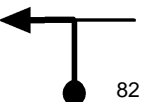
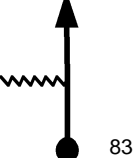
20 de março de 2016		Pág: 006	
0.06		34	
0.12		35	24 00.12.50 V T5
0.29		36	
0.34		37	30 00.13.23 V T6
0.44		38	
0.77		39	
0.86		40	
0.89		41	
0.95		42	
1.04		43	
1.43		44	



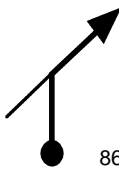
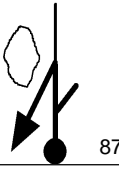

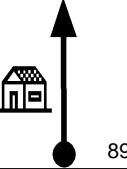
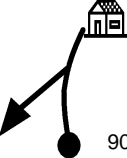

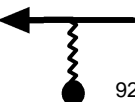
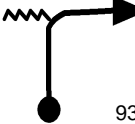
20 de março de 2016		Pág: 007	
1.46		2' N	00.15.37 T7
1.46		36 V	00.17.37 T8
1.54			
1.84			
1.87			
2.11			
2.14			
2.64		25 V	00.19.35 T9
2.96			
3.22			
3.38		1'30s N	00.21.22 T10

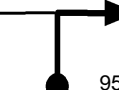
20 de março de 2016		Pág: 008	
3.38		39 V	00.22.52 T11
3.60			
3.86			
4.03			
			
4.16		35 V	00.24.04 T12
0.00			
0.03			
0.23			
0.30			
0.48		27 V	00.24.53 T13

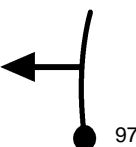
20 de março de 2016		Pág: 009	
0.70			
0.75			
0.90		36 V	00.25.49 T14
1.20			
1.76			
1.89			
2.10		27 V	00.27.49 T15
CUIDADO NAO ERRE!!!			
2.19			
2.30			
2.43			

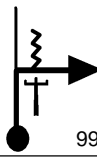
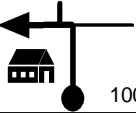
20 de março de 2016		Pág: 010	
2.47		75	
2.58		76	
2.62		77	
2.78		78	35 00.29.20 V T16
2.83		79	
2.88		80	
2.96		81	32 00.29.38 V T17
3.32		82	
3.47		83	
PERIDO			
ABISMO			
3.51		84	2' 00.30.40 N T18

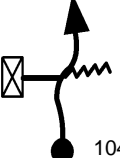
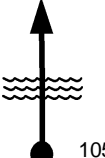

20 de março de 2016		Pág: 011	
3.51		85	39 00.32.40 V T19
3.71		86	
4.55		87	
4.67		88	33 00.34.27 V T20
4.83		89	
5.12		90	32 00.35.16 V T21
5.20		91	
5.28		92	
5.60		93	
5.74		94	
6.37		95	2' 00.37.37 N T22





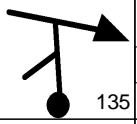

20 de março de 2016		Pág: 012	
0.00		96	39 00.39.37 V T23
0.13		97	
0.25		98	
0.69		99	33 00.40.41 V T24
0.75		100	
0.98		101	30 00.41.12 V T25
ENTRE NO MATO			
1.15		102	
1.28		103	
1.32		104	35 00.41.53 V T26
1.42		105	

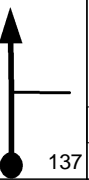
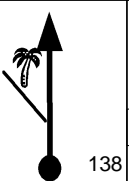
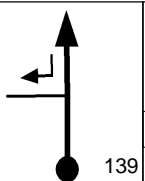
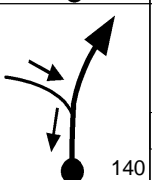
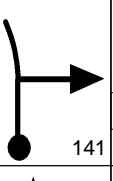
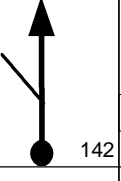
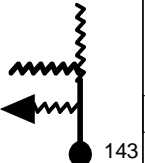
20 de março de 2016		Pág: 013	
1.69		106	
1.76		107	
2.01		108	
CUIDADO ESTRADÃO CRUZAMENTO			
2.37		109	1' 00.43.41 N T27
2.37		110	36 00.44.41 V T28
2.69		111	
2.82		112	37 00.45.26 V T29
ACELERE			
2.87		113	
3.08		114	
3.14		115	30 00.45.57 V T30



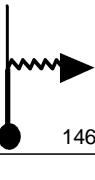
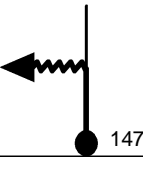
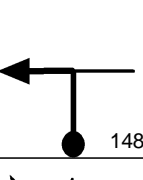
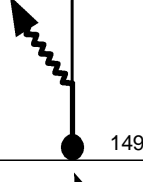



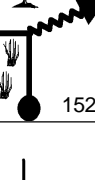

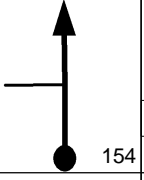
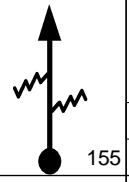
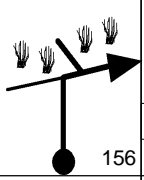
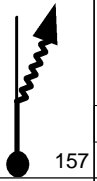
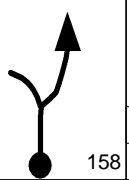
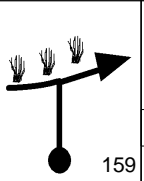
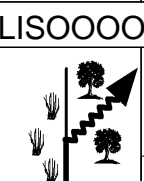
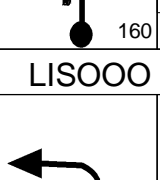
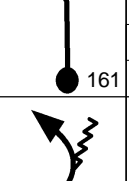
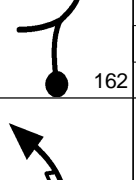

20 de março de 2016		Pág: 014	
3.30		116	
3.45		117	
3.51		118	
3.63		119	23 00.46.56 V T31
RAIZEIRO LISOOOOOO			
3.66		120	
PELA ESQUERDA BANHADO			
3.96		121	
4.13		122	
4.89		123	

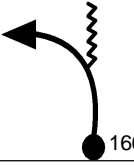





20 de março de 2016		Pág: 015	
4.98		124	26 00.50.27 V T32
5.15		125	
5.19		126	
5.25		127	
5.33		128	
5.47		129	
5.51		130	
SIGA OS BAMPS			
5.58		131	26 00.51.50 V T33
INICIO DESLOCAMENTO			
BAMPS			
5.69		132	4' 00.52.06 D T34
5.78		133	



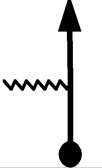

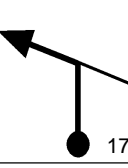
20 de março de 2016		Pág: 016	
5.89		134	
NA PRINCIPAL			
FIM			
DESLOCAMENTO			
6.01		135	
0.00		42	00.56.06
		V	T35
0.67		136	
0.92		137	
1.10		138	
MOTO CONTRA			
1.31		139	
1.50		140	
1.88		141	
		36	00.58.47
		V	T36
2.54		142	
3.02		143	
		25	01.00.41
		V	T37

20 de março de 2016		Pág: 017	
3.13		144	
3.17		145	
NO EUCALIPTO			
3.24		146	
3.30		147	
3.45		148	
3.49		149	
3.86		150	
BAMP			
3.90		151	
ENTRE			
NO MATO			
4.04		152	
		28	01.03.08
		V	T38
4.38		153	
		26	01.03.51
		V	T39

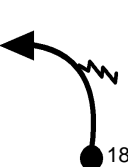
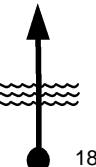
20 de março de 2016		Pág: 018	
4.40		154	
4.52		155	
4.54		156	
4.65		157	
5.03		158	
5.05		159	
LISOOOO			
5.11		160	
		26	01.05.32
		V	T40
LISOOO			
5.16		161	
5.32		162	
		30	01.06.02
		V	T41
6.10		163	

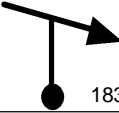
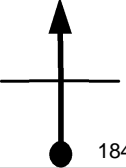
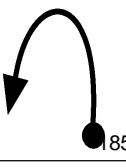
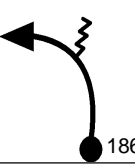
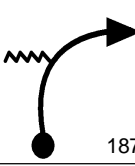
20 de março de 2016		Pág: 019	
6.28		164	
6.33		165	
6.42		166	
6.51		167	
6.61		168	
FURNINHAS			
6.89 0.00		169	4' 01.09.10 N T42
0.00		170	36 01.13.10 V T43
0.04		171	
0.24		172	
VAMOS COMEÇAR A BRINCADEIRA!			
"BEM VINDOS"			
0.69		173	32 01.14.19 V T44

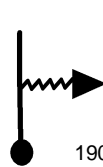
20 de março de 2016		Pág: 020	
1.03		174	
1.09		175	
1.37		176	
1.51		177	
1.57		178	
1.91		179	
			
2.20		180	30 01.17.09 V T45
2.50		181	
2.97		182	

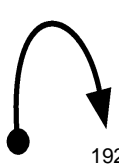
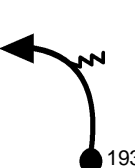
20 de março de 2016		Pág: 021	
3.73		183	
3.88		184	
4.35		185	
4.63		186	26 01.22.00 V T46
4.82		187	
4.84		188	
5.06		189	
5.13		190	
5.26		191	
5.45		192	
5.61		193	34 01.24.16 V T47

5.73		194	
6.08		195	28 01.25.06 V T48
6.18		196	
6.33		197	
6.41		198	
6.43		199	
DESCE			
6.75		200	
7.21		201	
SOBE			
7.43		202	
7.48		203	

7.54		204	
7.85		205	
7.94		206	
8.08		207	33 01.29.23 V T49
8.32		208	
8.36		209	
8.37		210	
8.41		211	
NAO SALTE PERIGO			
8.74		212	
8.77		213	





8.88		214	
8.94		215	
9.08		216	3' 01.31.12 N T50
0.00		217	28 01.34.12 V T51
0.05		218	
0.27		219	
0.31		220	
0.41		221	
INICIO DESLOCAMENTO			
0.55		222	3' 01.35.23 D T52
0.65		223	

20 de março de 2016		Pág: 025	
0.73		224	
0.82		225	
FIM DESLOCAMENTO			
0.87		226	36 01.38.23 V T53
1.18		227	
1.38		228	
1.98		229	
MAO NA SOCA			
2.15		230	35 01.40.31 V T54
2.45		231	
2.61		232	
2.89		233	

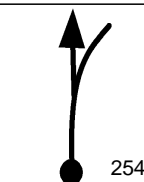
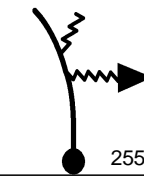
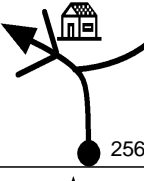
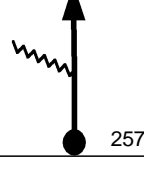
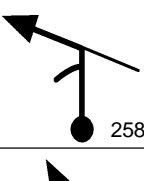
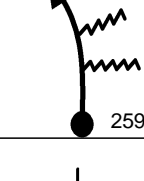
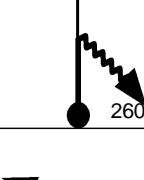
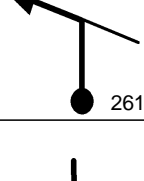
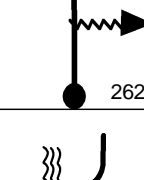
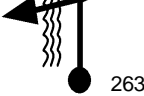
20 de março de 2016		Pág: 026	
2.91		234	xxxx0 0xxxx
3.30		235	
3.48		236	
3.52		237	
3.85		238	
3.91		239	
4.24		240	
4.44		241	
4.56		242	27 01.44.39 V T55

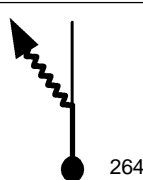
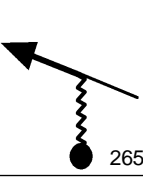
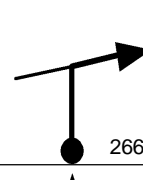
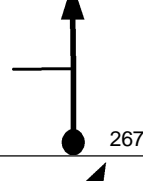
20 de março de 2016		Pág: 027	
4.61		243	xxxx0 0xxxx
4.85		244	
5.05		245	
5.09		246	33 01.45.49 V T56
5.34		247	
5.94		248	
6.01		249	2' 01.47.30 N T57
6.01		250	36 01.49.30 V T58
6.13		251	
6.29		252	39 01.49.58 V T59
0.86		253	

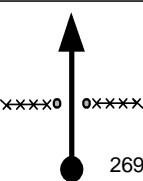
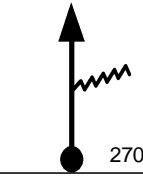
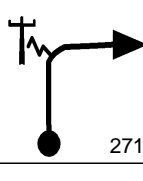
20 de março de 2016		Pág: 028	
SAIA			
DA			
PRINCIPAL			
1.00		24	01.51.30 V T60
1.15			
1.29			
1.31			
1.48			
1.51			
1.56			
1.74			
1.92		18	01.53.48 V T61
2.01			

20 de março de 2016		Pág: 029	
2.03			
2.06			
2.20			
2.25			
2.53		25	01.55.50 V T62
PASTO			
2.97			
3.03			
3.10			
3.20			
COMUNIDADE			
RIO PINHEIROS ALTO			
3.30		2'	01.57.41 N T63

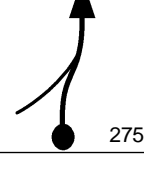
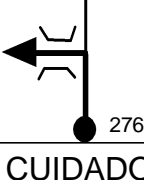
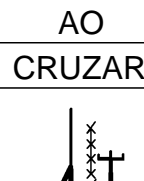
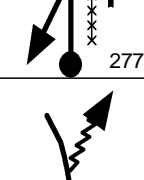
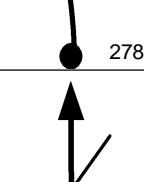
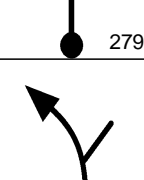
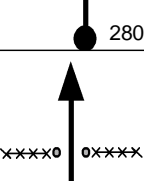
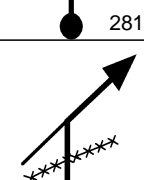
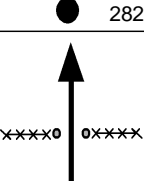
20 de março de 2016		Pág: 030	
3.30		39	01.59.41 V T64
3.35			
3.75			
CUIDADO			
AO			
CRUZAR			
4.68			
4.81		32	02.02.00 V T65
4.91			
5.02			
5.15			
5.26			
5.33			

20 de março de 2016		Pág: 031	
5.44		284	
5.52		285	
5.63		286	30 02.03.33 V T66
5.80		287	
6.26		288	
6.32		289	
6.54		290	
6.57 0.00		291	2' 02.05.25 N T67
0.00		292	42 02.07.25 V T68
0.39		293	
0.69		294	









20 de março de 2016		Pág: 032	
0.82		295	
1.02		296	
1.50		297	
2.31		298	
3.80		299	
4.78		300	
INICIO DESLOCAMENTO			
4.84		301	5' 02.14.20 D T69
5.55		302	
CUIDADO RODOVIA ESTADUAL			

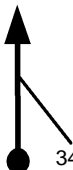
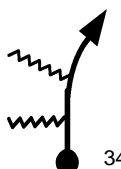

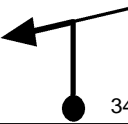



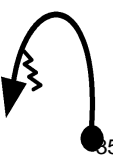



20 de março de 2016		Pág: 033	
5.58		303	
5.77		304	
APOIO COMUNIDADE TAIPA			
5.85 0.00		305	19' 02.19.20 N T70
0.00		306	42 02.38.20 V T71
0.10		307	
0.21		308	
0.70		309	
1.03		310	38 02.39.48 V T72
1.85		311	
2.16		312	



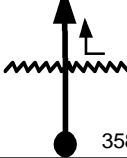

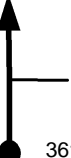

20 de março de 2016		Pág: 034	
2.49		313	
DESCIDA DA TORRE			
2.75		314	28 02.42.31 V T73
4.06		315	
4.15		316	
4.61		317	26 02.46.31 V T74
SOBE			
4.66		318	
4.77		319	
4.84		320	
NO EUCALIPTO			
4.86		321	
4.93 0.00		322	2' 02.47.15 N T75



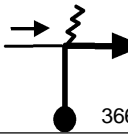

20 de março de 2016		Pág: 035	
0.00		323	33 02.49.15 V T76
0.08		324	
ASFALTO			
0.21		325	42 02.49.38 V T77
0.70		326	
1.04		327	
1.21		328	
1.97		329	
2.28		330	
2.42		331	35 02.52.47 V T78
2.72		332	

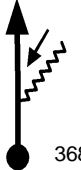
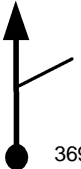
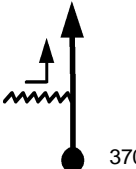



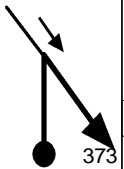
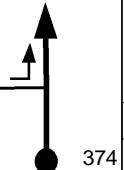
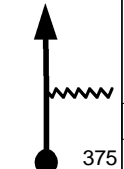
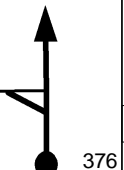

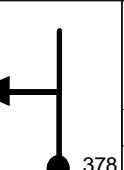
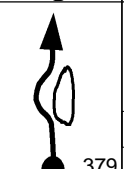
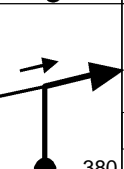
20 de março de 2016		Pág: 036	
2.79		333	
3.56		334	32 02.54.44 V T79
4.02		335	
4.17		336	2' 02.55.53 N T80
4.17		337	39 02.57.53 V T81
4.40		338	
CUIDADO AO CRUZAR!			
4.54		339	32 02.58.27 V T82
4.66		340	
4.92		341	
4.95		342	

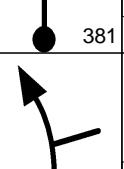

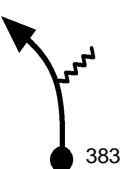
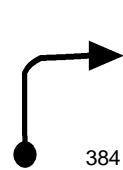

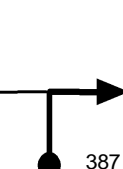
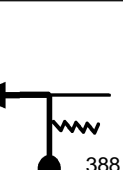
20 de março de 2016		Pág: 037	
5.01		343	
5.12		344	
5.16		345	
5.30		346	24 02.59.53 V T83
5.50		347	
5.63		348	
5.81		349	30 03.01.09 V T84
5.83		350	
5.87		351	
6.04		352	
6.33 0.00		353	2' 03.02.12 N T85

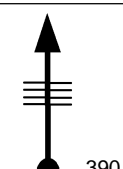
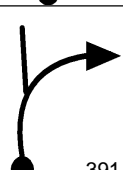



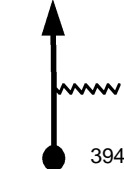

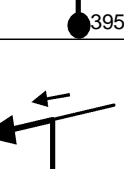
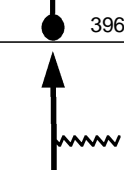
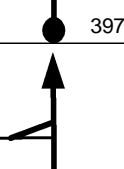
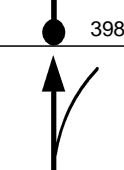
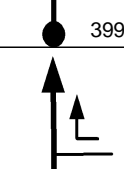
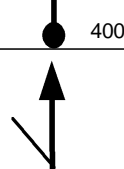

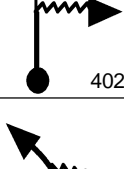

20 de março de 2016		Pág: 038	
0.00		354	36 03.04.12 V T86
0.06		355	
0.30		356	42 03.04.42 V T87
LIMPANDO A VELA			
1.21		357	45 03.06.00 V T88
1.63		358	
2.22		359	18 03.07.20 V T89
			
BAMP'S			
2.40		360	
2.62		361	28 03.08.40 V T90
2.72		362	

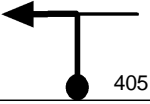

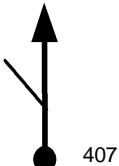

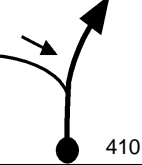

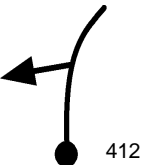

20 de março de 2016		Pág: 039	
2.88		363	
2.98		364	
3.07		365	
3.16		366	42 03.09.50 V T91
3.75		367	
3.80		368	
4.09		369	
4.13		370	
4.26		371	28 03.11.24 V T92
LISOOOOO			
4.44		372	

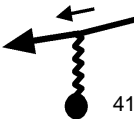

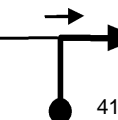

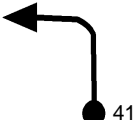
20 de março de 2016		Pág: 040	
4.84		36 V	03.12.39 T93
5.17			
5.31			
5.37			
5.75			
5.96		25 V	03.14.31 T94
6.01			
6.28		28 V	03.15.17 T95
ACELERE			
6.50		26 V	03.15.45 T96
6.65			

20 de março de 2016		Pág: 041	
6.69			
6.82			
6.87			
6.93			
6.97			
7.00		3' N	03.16.54 T97
0.00		36 V	03.19.54 T98
0.22			
0.34			
0.44		28 V	03.20.38 T99
0.48			

20 de março de 2016		Pág: 042	
0.58			
ACELERE			
0.80			
0.97		34 V	03.21.46 T100
1.11			
1.18			
1.56		30 V	03.22.49 T101
1.80			
2.02			
ATENÇÃO			
2.56			
2.80			

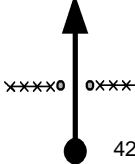
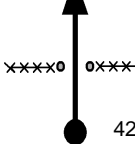
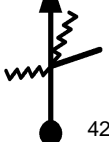
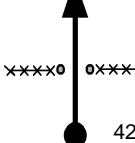
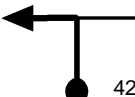
20 de março de 2016		Pág: 043	
 ABISMO			
3.06		404	
3.37		405	2' 03.26.26 N T102
3.37		406	36 03.28.26 V T103
3.52		407	
FAÇA NA CAVEIRA			
3.88		408	28 03.29.17 V T104
4.09		409	
4.25		410	
4.28		411	
4.62		412	26 03.30.52 V T105
4.85		413	

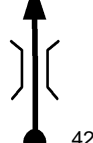







20 de março de 2016		Pág: 044	
5.04		414	
5.06		415	
5.13		416	
5.46		417	
5.53		418	
5.77		419	30 03.33.31 V T106
			
6.10		420	
EROSÕES			
7.00		421	28 03.35.59 V T107
CUIDADO EROSÕES			

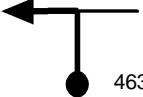
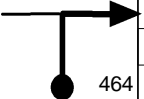
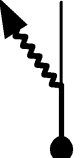
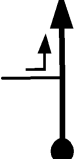

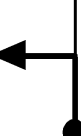

20 de março de 2016		Pág: 045	
7.17		422	
7.39		423	
7.42		424	
7.49		425	
7.55 0.00		426	3' 03.37.10 N T108
0.00		427	37 03.40.10 V T109
0.61		428	
0.66		429	
RIO CORAL			
0.88		430	
0.94		431	





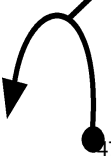
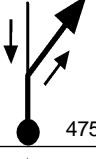

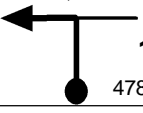
20 de março de 2016		Pág: 046	
1.00		432	
1.89		433	
2.09		434	
2.21		435	
2.85		436	
2.91		437	
3.00		438	
3.15		439	
3.22		440	33 03.45.23 V T110
EROSÕES			
3.29		441	

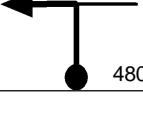
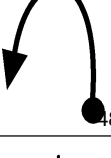
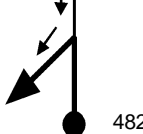
20 de março de 2016		Pág: 047	
3.53		442	
3.82		443	32 03.46.28 V T111
3.98		444	
4.20		445	
4.49		446	
5.03		447	
5.05		448	
5.16		449	2' 03.48.59 N T112
0.00		450	36 03.50.59 V T113
0.31		451	
0.95		452	

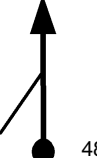
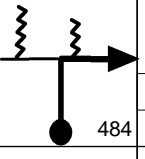
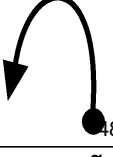
20 de março de 2016		Pág: 048	
1.10		453	
1.26		454	
1.33		455	30 03.53.12 V T114
EROSÃO			
1.40		456	
1.65		457	30 03.53.51 V T115
1.94		458	
2.09		459	
2.27		460	
2.57		461	
2.67		462	28 03.55.53 V T116

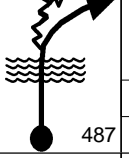
20 de março de 2016		Pág: 049	
3.15		463	
3.34		464	
3.47		465	
3.80		466	
3.93		467	
4.01		468	
4.04		469	32 03.58.49 V T117
4.16		470	
4.19		471	
4.32		472	25 03.59.21 V T118
4.56		473	

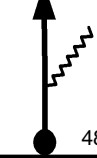

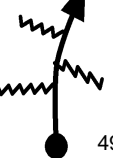

20 de março de 2016		Pág: 050	
5.33		474	
5.57		475	32 04.02.21 V T119
5.74		476	
5.98		477	27 04.03.07 V T120
6.74		478	1'30s 04.04.48 N T121
0.00		479	32 04.06.18 V T122
			
0.13		480	
0.50		481	
0.75		482	





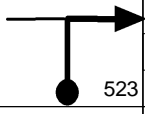

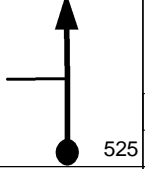
20 de março de 2016		Pág: 051	
0.91		483	
1.15		484	
1.46		485	24 04.09.02 V T123
EROSÕES			
☠☠☠ DESCIDA			
1.53		486	
PELA DIREITA			
1.65		487	
1.90		488	
2.15		489	
DESLOCAMENTO			
2.20		490	3'30s 04.10.53 D T124
2.54		491	
FIM DESLOCAMENTO			

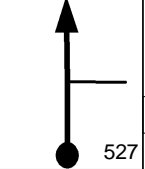
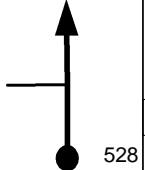
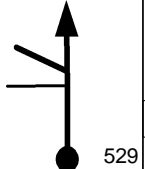
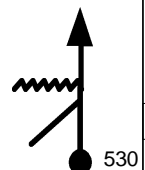
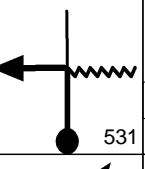
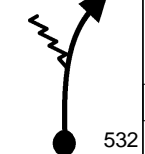
20 de março de 2016		Pág: 052	
2.63		40 04.14.23 V T125	492
3.55			493
3.57			494
3.91			495
4.25			496
4.52			497
4.63		35 04.17.23 V T126	498
4.66			499
4.69			500
4.76			501
4.95			502

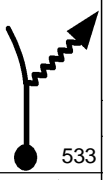
20 de março de 2016		Pág: 053	
5.05			503
5.44			504
5.49			505
5.80			506
DESLOCAMENTO			
6.14		5' 04.19.59 D T127	507
6.35			508
6.81			509
6.84			510
FIM DESLOCAMNETO			
6.86		30 04.24.59 V T128	511
6.96			512

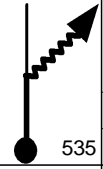
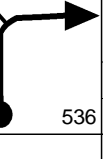
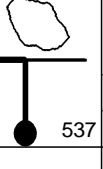
20 de março de 2016		Pág: 054	
7.06			513
7.12			514
ABISMO			
7.22			515
7.43			516
7.48			517
7.52		32 04.26.18 V T129	518
7.82			519
8.03			520
EROSÕES PERIGO			
8.12			521
8.41			522

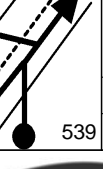
20 de março de 2016		Pág: 055	
PARE			
☠☠☠ PERIGO			
8.67 0.00		2' N	04.28.27 T130
0.00		42 V	04.30.27 T131
0.11		525	
0.47		526	
0.54		527	
1.03		528	
1.18		529	
1.74		38 V	04.32.56 T132
CUIDADO AO CRUZAR			
1.86		531	
2.31		532	

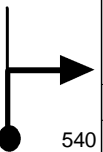
20 de março de 2016		Pág: 056	
2.67		30 V	04.34.24 T133
2.80		534	
SOBE			
3.45		535	
3.50		536	
4.08		2' N	04.37.14 T134
4.08		42 V	04.39.14 T135
5.97		539	
			
RESPEITE OS MORADORES			
7.30		33 V	04.43.50 T136

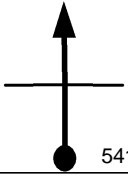
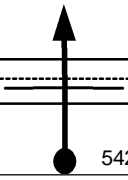
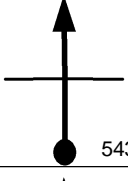
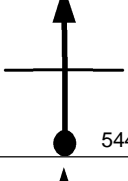
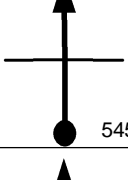
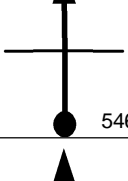
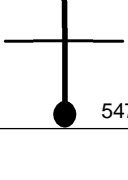
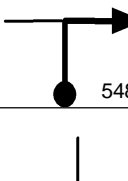
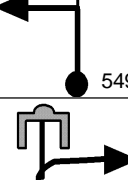
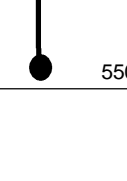
20 de março de 2016		Pág: 057	
7.36		541	
PARE			
☠☠☠ ASFALTO			
7.44		542	
7.51		543	
7.60		544	
7.68		545	
7.75		546	
7.82		547	
7.91		38 V	04.44.56 T137
8.05		549	
8.32		550	

8.61

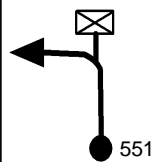

8.76

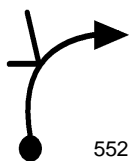

FIM DE PROVA

PARABENS!!

8.82

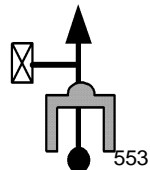

FIM DE PROVA !!



www.t15.com.br

Tempo de Prova

OVER45 - DUPLA - ESTRE 04:46:22

FIM